

Metal Bellows Coupling compact

with Collet Clamps

optional
laserwelded
optional full stainless
steel version

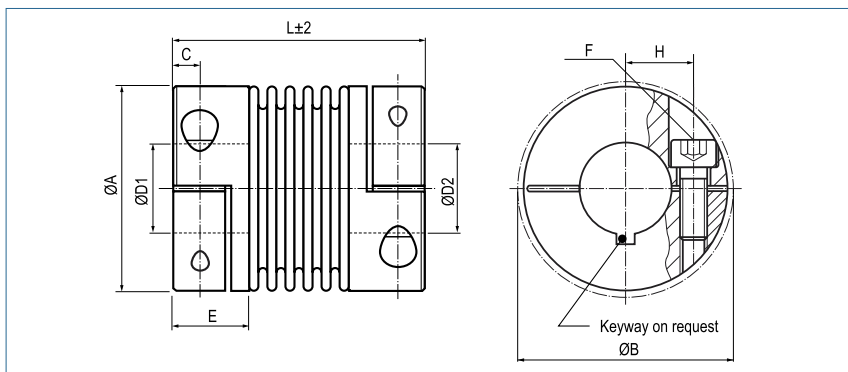

Order Code

KB4C / 60 - 67 - 12 - 32 - (S)

Type / Size

Length
L

ØD1
(H7)

ØD2
(H7)

Options

Size	Torque TKN (Nm)	Dimensions (mm)								Technical Data								
		L	Ø A	D1/D2	H	C	E	B	F	Mass (kg)	Moment of Inertia J (g m²)	Spring Stiffness			Misalignment			max. speed min-1
		Length	Outer Ø	Bore Sizes (H7) min~max					Screw (ISO4762) TA (Nm)			torsional CT 10³ (Nm/rad)	radial CR (N/mm)	axial CA (N/mm)	radial ΔKr (mm)	axial ΔKa (mm)	angular ΔKw (°)	
18	18	58	45	10-25.4	17	5.5	17.5	47.4	M5	0.07	0.03	20	205	50	0.2	0.5	1.5	12800
		8							0.12	0.04	15	82	36	0.25	0.5	2	12800	
30	30	58	56	10-32	20	7.3	21	56.4	M6	0.26	0.13	38	720	50	0.15	0.6	1.5	10300
		15		0.27					0.14	28	225	28	0.25	1	2	10300		
60	60	67	66	12-35	24	8.6	24	66.2	M8	0.38	0.28	75	1150	90	0.15	0.6	1.5	8700
		40		0.42					0.31	50	340	50	0.25	1	2	8700		
80	80	78	82	12-44	28	9.8	27	82.9	M10	0.70	0.78	128	1200	80	0.2	0.5	1.5	6900
		84		0.76					0.85	75	400	50	0.25	0.8	2	6900		
150	150	78	82	14-44	28	9.8	27	82.9	M10	0.73	0.82	155	2020	145	0.2	0.5	1.5	6900
		84		0.80					0.89	105	595	85	0.25	0.8	2	6900		
200	200	83	90	16-47	31	10.8	29	90.8	M12	0.89	1.19	175	2500	145	0.2	0.5	1.5	6400
		125		0.95					1.27	120	460	82	0.25	0.8	2	6400		
300	300	94	110	20-60	40	11.8	32.5	110	M12	1.37	2.74	502	6300	280	0.2	0.5	1.5	6000
		145		1.43					2.86	285	1400	145	0.25	0.8	2	6000		
500	500	100	122	25-70	42	13.3	36	122	M12	1.81	4.45	690	7790	100	0.2	0.5	1.5	5000
		145		1.91					4.69	320	970	85	0.25	1	2	5000		

Material	bellows - stainless steel hub - aluminium
Hub	bore tolerance: H7
Temperature Range	-30 °C ~ 120 °C
Keyway	optional acc. DIN 6885 biggest bore marked with a #